

User's Manual **ST-81**zPID



WWW.TECH-REG.COM

TECH



Declaration of Conformity No. 23/2007

Hereby, we declare under sole responsibility that the **ST-81** 230V 50Hz thermoregulator manufactured by TECH, Wieprz 1047A, 34-122 Wieprz, is compliant with the Regulation by the Ministry of Economy. (Journal of Laws Dz.U. 155 Item 1089) of July 21, 2007 implementing provisions of the Low Voltage Directive (**LVD**) **2006/95/EC** of January 16, 2007.

The **ST-81** controller has been tested for electromagnetic compatibility (EMC) with optimal loads applied.

For compliance assessment, harmonized standards were used:
PN-EN 60730-2-9:2006.

Co-owners:

Paweł Jura, Janusz Master



ATTENTION!

HIGH VOLTAGE!

Make sure the regulator is disconnected from the mains before working on the power supply (cable connections, device installation, etc.)!

All connection works must only be carried out by qualified electricians.

Before activating the controller, measure the motor resetting efficiency, check the boiler and inspect wire insulation.

CAUTION!



**THE DEVICE MAY BE DAMAGED
IF STRUCK BY A LIGHTNING.
MAKE SURE IT IS UNPLUGGED
DURING STORMS**

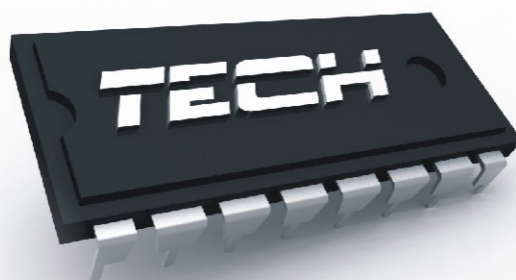

I. Description

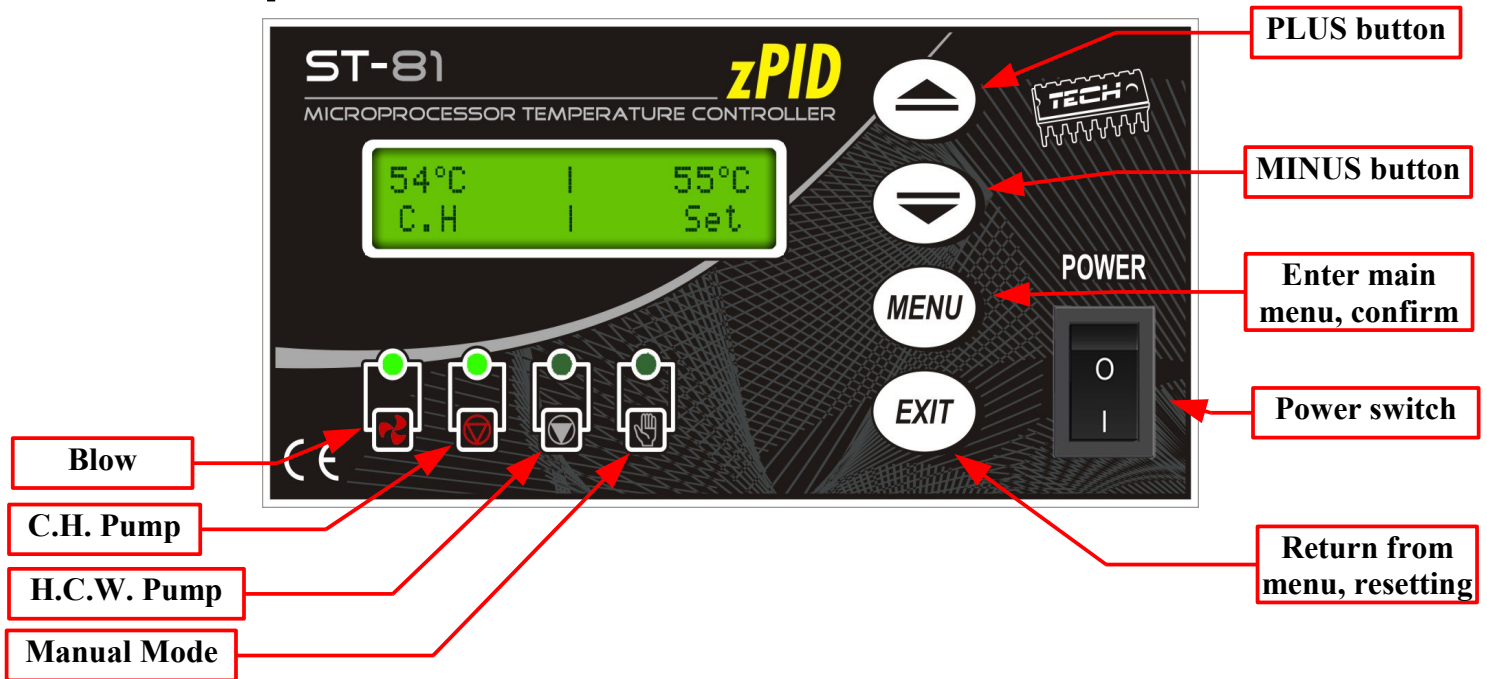

The **ST-81zPID** temperature regulator is intended for use with central heating boilers. The regulator is used for controlling the central heating water circulation pump, hot consumption water pump and blow (fan).

The ST-81zPID is a PID-based controller **using a continuous signal**. In this type of controllers, the fan power is calculated based on boiler temperature and flue gas temperature measured at the boiler outlet. The fan runs continuously and its power depends directly on the measured boiler temperature and flue gas temperature as well as the difference between the two parameters and their setpoint values. Advantages of zPID regulators include their ability to maintain a stable setpoint temperature without unnecessary overregulations and oscillations.

By fitting the controller with a flue gas outlet sensor, you can save from a few up to several percent of fuel, and ensure a steady water temperature for a longer service life of your heat exchanger (boiler). Flue gas outlet temperature monitoring ensures reduced harmful dust and gas emissions. The thermal energy from the flue gases is used for heating instead of being wasted and disposed of through the funnel.

ST-81zPID – USER'S MANUAL

Research results presented below were obtained using the **TECH** PID-based controller:

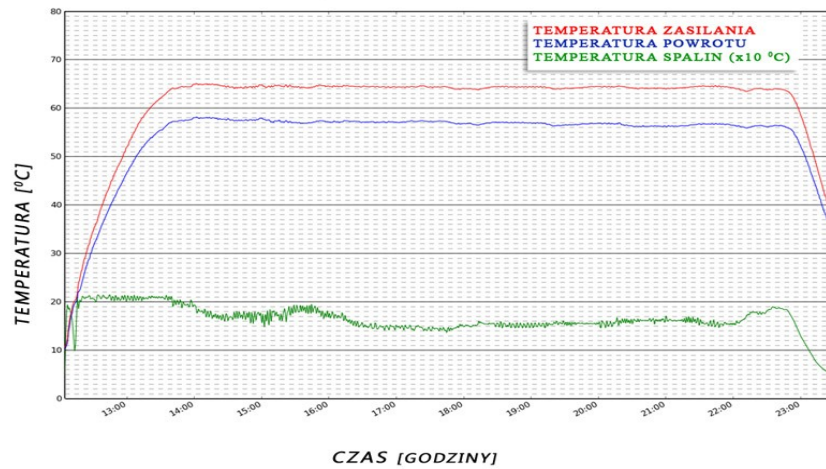

and the controller without PID control:

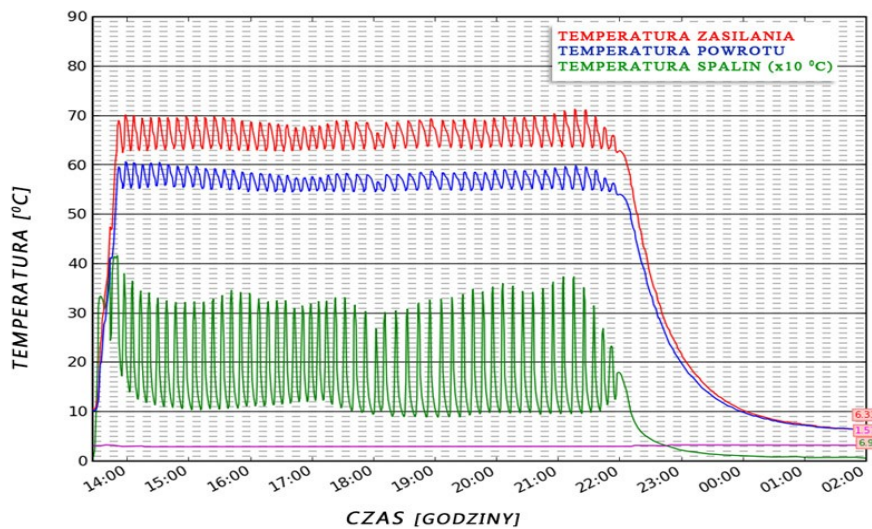

In each case, the software version is customized to the furnace manufacturer's requirements. Please send all comments on the software to the boiler manufacturer.

Your controller should be set according to your individual needs, depending on the type of fuel and boiler used. **TECH** shall not be held responsible for incorrect settings.

1.a) Basic Terms

Fire up. The cycle begins when you activate the *fire up* function in the controller's menu and is active until the central heating boiler temperature reaches 40°C (the default *fire-up threshold*), on condition that the temperature does not drop below this value for 2 minutes (the default *fire-up time*). If these conditions are met, the regulator will switch to the *duty* mode and the *manual operation symbol* on the housing will be deactivated. If the controller fails to reach parameters required for entering into the *duty* mode within 30 minutes from activation of the *fire-up* function, the "*Unable to fire up*" message will appear on the display. In such a case, the fire-up cycle needs to be restarted.

Duty – once the *fire-up* cycle is finished, the controller enters the *duty cycle*. The duty cycle is the basic functionality of the regulator. The blow is controlled automatically using the zPID algorithm and the temperature is close to its setpoint value. In the user menu, *fan* item will appear in place of the *fire-up* function. The fan can be deactivated when needed (e.g. while feeding fuel). If the temperature rises unexpectedly by more than 5°C over the setpoint value, the so-called *Supervision Mode* is activated.

Supervision Mode – the mode is activated during the *Duty Cycle* if the temperature rises by more than 5°C over the setpoint value. In such case, the controller is switched from the PID control to manual settings (according to parameters entered in the Fitter's Menu) to reduce the temperature of the circulation water.

Damping – if boiler temperature drops by 2°C below the *fire-up threshold* and fails to rise above this value for 30 minutes (default *damping time*), the regulator will switch to the *damping mode*. While in this mode, the fan is deactivated and the display shows "*Damping*".

II. Regulator Functionality

This chapter describes regulator functionality, how to change settings and navigate in the menu with the buttons. Depending on the mode the boiler is currently in, the display will show boiler operational parameters. The given mode is selected by the user.

II.a) Main Page

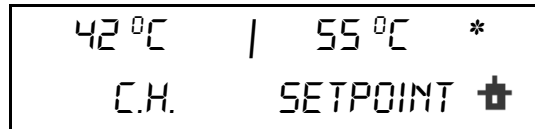

During normal operation, the **LCD** display shows the *Main Page* containing the following:

- **Boiler temperature** (to the left of the display).
- **Setpoint temperature** (to the right of the display).
- **Fan stop.** After manually stopping the fan while in the *duty mode*, the star symbol (☆) will appear in the up right corner.
- **Operation Mode.** In the up right corner, the corresponding letter of the operation mode is displayed. Depending on the operation mode, the corresponding symbol is displayed:

☆ – house heating,

W – water heater priority,

P – parallel pumps,

S – summer mode.

In order to check the flue gas outlet temperature, press **EXIT** (hold for several seconds) until the following screen is displayed:

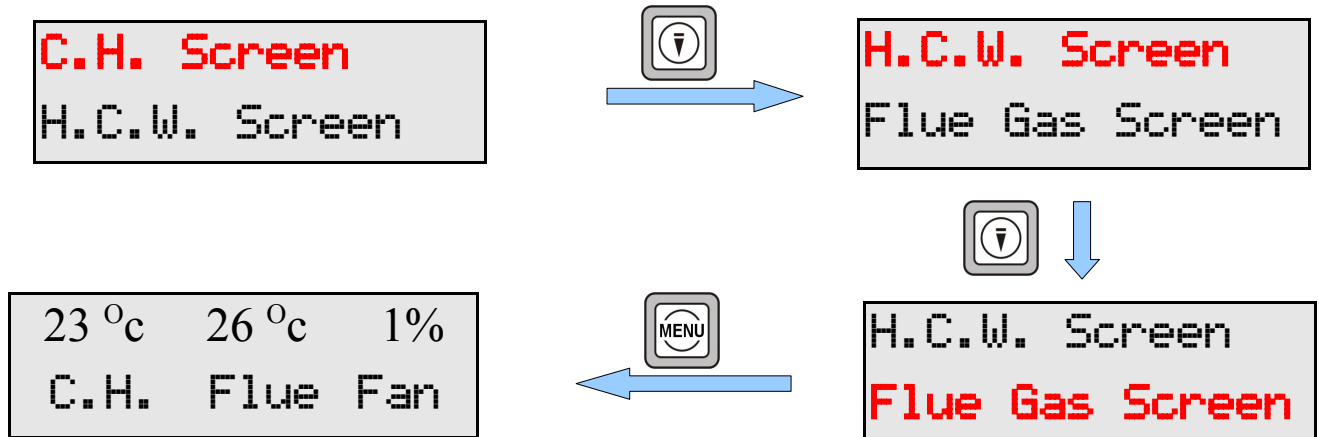

The left of the screen shows the boiler temperature; the middle of the screen shows the flue gas outlet temperature; the right of the screen shows the power of the fan. Press EXIT to return to the main menu.

ST-81 thermal controller is designed for central heating boilers. ST-81 thermoregulator is designed for wood-fired central heating boilers. It controls water circulating pump and air injection (fan). However, this type of controller cannot control rotation of the fan.

Pressing the *MENU* button will move you to the main menu. The display shows two options of the menu. To select a different option, press *PLUS* or *MINUS* button.

II.b) Changing the central heating and hot consumption water setpoint temperature.

In order to change the setpoint temperature of the central heating (while in "C.H. screen" main view), press *PLUS* or *MINUS* button and (after setting a desired value) press *MENU* to confirm the change.

In order to change the setpoint temperature of the hot consumption water (while in "H.C.W. screen" main view), press *PLUS* or *MINUS* button and (after setting a desired value) press *MENU* to confirm the change.

Chapter "Screen" describes methods of changing the main screen view.

II.c) Firing up/Fan

This function allows you to easily fire up the boiler. After igniting the boiler, you need to activate an automatic fire-up cycle. By selecting optimum parameters, the boiler uses the zPID function to smoothly switch to the duty mode. If the boiler reaches the *fire-up threshold* temperature, the *fan* item will appear instead of the *fire-up* function. From now on, the option will be used to activate/deactivate the fan. This setting allows you to temporarily deactivate the fan at any time, e.g. while feeding fuel.

If during the fire-up cycle the boiler does not reach 40°C **within 30 minutes**, (default parameters), the following warning message will appear on the display:



38 °C | 55 °C
UNABLE TO FIRE UP

To restore the boiler to operation, switch off **the alarm** by pressing the button *MENU* and restarting the **fire-up** procedure.

II.d) Manual Mode

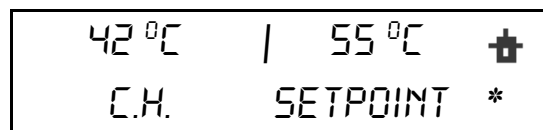

42 °C | 55 °C +
C.H. SETPOINT *

For your convenience, the regulator features a **manual mode module**. In this mode, each individual actuator is enabled and disabled independently of the other. In addition to the **Manual Mode** function, the **Blow Force** function has been provided.



BLOW FORCE
FAN

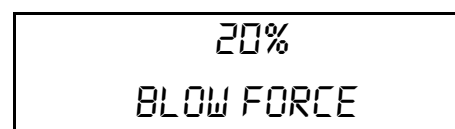

20%
BLOW FORCE

This function allows you to set the blow force of the fan while in the **Manual Mode**.

Pressing *MENU* activates the fan. The fan will operate until button *MENU* is pressed again.

```
BLOW FORCE
FAN
```

Press *MENU* to enable / disable the central heating pump.

```
FAN
C.H. PUMP
```

Press *MENU* to enable / disable the (water heater) hot consumption water pump.

```
C.H. PUMP
H.C.W. PUMP
```

Press *MENU* to enable / disable the alarm.

```
H.C.W. PUMP
ALARM
```

II.e) Fuel Type

```
42 °C | 55 °C +
C.H. SETPOINT
```

```
MANUAL MODE
FUEL TYPE
```

```
COAL
FINES
```

This option allows you to select one of three fuel types (coal, fines and wood) for use in the boiler. Each fuel type has a fan operation mode assigned to ensure the right burning process.

II.f) Central Heating Pump Activation

```
42 °C | 55 °C +
C.H. SETPOINT
```

```
FUEL TYPE
C.H. PUMP ACTIVATION
```

```
35 °C
C.H. PUMP ACTIVATION
```

With this function, you can set the temperature that will activate the central heating pump (the temperature is measured on the boiler). The pump

ST-81zPID – USER'S MANUAL

will start if the setpoint temperature is exceeded. The pump will be deactivated when the boiler temperature drops below the activation temperature (minus hysteresis, e.g. 2°C). In this case, the pump will stop at boiler temperature of 33°C.

II.g) H.C.W. Pump Activation

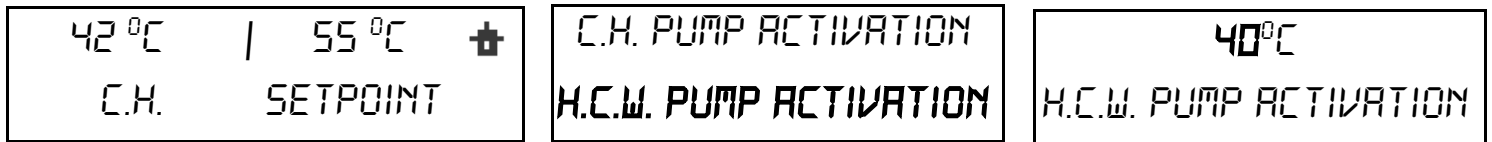

With this function, you can set the temperature that will activate the hot consumption water pump (the temperature is measured on the boiler). Above the setpoint temperature (e.g. 40°C), the pump is activated and operates depending on the selected operation mode. The pump will be deactivated when the boiler temperature drops below the activation temperature (minus hysteresis, e.g. 3°C). In this case, the pump will stop at boiler temperature of 37°C.

II.h) Operation Mode

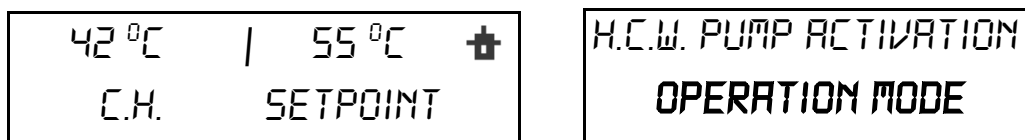

With this function, you can select one out of four operation modes.

II.h.1) House Heating



If you select this option, the regulator will switch to the house heating mode. The central heating pump starts to run above the pump activation temperature (set to 35°C by default). Below this temperature (minus central heating hysteresis), the pump is shut off. While in the *house heating* mode,

the icon  is displayed in the up right corner of the main screen.

II.h.2) H.C.W. Priority



Activating the hot consumption water priority will cause the regulator to switch into the water heater priority mode. In this mode, the (hot consumption water) heater pump is activated until the set H.C.W. temperature is reached. Then, the H.C.W. pump is shut off and the C.H. pump is activated. The central heating pump will run until the water heater temperature drops below the setpoint value (and the H.C.W. hysteresis); then, the C.H. pump is shut off and the H.C.W. pump is activated.

In this mode, the fan is operated as long as the temperature is below 62°C to prevent the boiler from overheating.

The hot consumption water priority function consists in that the consumption water is heated up before heating up water in radiators.

While in the *H.C.W. Priority* mode, the icon  is displayed in the up right corner of the main screen.

ATTENTION: The boiler should have non-return valves mounted on the central heating pump circuit and the hot consumption water pump circuit. A valve mounted on the hot consumption water pump will prevent hot consumption water from being drawn from the water heater.

II.h.3) Parallel Pumps

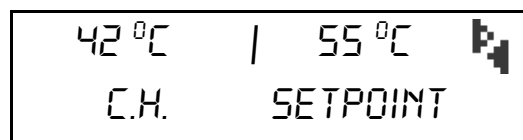

In this mode, the pumps start to run in parallel above the pump activation temperature (set by default to 35°C). These temperatures may, however, vary depending on user settings. This will cause irregular activation of the

pumps. However, when both thresholds are exceeded, the pumps will operate simultaneously. The central heating pump runs continuously, while the hot consumption water pump stops after the setpoint temperature is reached in the water heater.

While in the *Parallel Pumps* mode, the icon  is displayed in the up right corner of the main screen.

ATTENTION: In this mode, a non-return valve should be fitted to maintain different temperatures in the water heater and in the house. After activation of the parallel pumps function, three items appear on the display. Starting from the left, these are: Boiler Temperature (C.H.); Water Heater Temperature (H.C.W.) and Setpoint Temperature (C.H.).

II.h.4) Summer Mode

PARALLEL PUMPS
SUMMER MODE *

45 °C	43 °C	55 °C	
C.H.	H.C.W.	SET	

When the function is enabled, only the hot consumption water pump is running in order to heat water in the water heater. The pump is switched on above a predefined activation threshold (see the *pump activation temperature* function) and will run until the setpoint temperature has been reached. The pump will start again when the temperature drops below the set hysteresis. In the Summer Mode, only the setpoint temperature is set on the boiler that heats up water for the water heater (the temperature set for the boiler is also the temperature set for the water heater).

While in the *Summer Mode*, the icon  is displayed in the up right corner of the main screen.

II.i) Main Screen

```

OPERATION MODE
MAIN SCREEN

```

This function allows you to change the view of the main screen. The following views are available:

➤ C.H. SCREEN

```

• C.H. SCREEN
H.C.W. SCREEN

```

```

44 °C | 55 °C ⬆
C.H.   SETPOINT

```

This screen displays the current and setpoint C.H. temperatures. By pressing *PLUS* or *MINUS* button, you can change the setpoint temperature. After setting the appropriate value, confirm it by pressing *MENU*.

➤ H.C.W. SCREEN

```

C.H. SCREEN
• H.C.W. SCREEN

```

```

43 °C | 50 °C ⬇
H.C.W. SETPOINT

```

This screen displays the current and setpoint H.C.W. temperatures. By pressing *PLUS* or *MINUS* button, you can change the setpoint H.C.W. temperature. After setting the appropriate value, confirm it by pressing *MENU*.

➤ FLUE GASES SCREEN

```

H.C.W. SCREEN
• FLUE GASES SCREEN

```

```

45 °C 93 °C 80% ⚡
C.H.  FLUE  FAN

```

The following items are displayed, starting from the left: current C.H. temperature, current flue gases temperature and blow power in percentages. This view is used for monitoring current boiler parameters.

II.j) Language



With this function, you can select the language of your controller.

II.k) Factory Settings

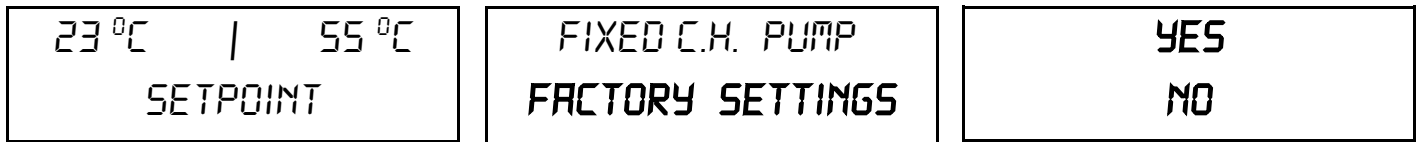

The regulator has been pre-configured. However, it should be adjusted to your individual needs. It is possible to return to the factory settings at any time. By enabling the **Factory Settings**, all existing boiler settings will be replaced by settings made by the manufacturer. From then on, you can again set your own operating parameters for the boiler.

II.l) Fitting parameters

Access to fitting parameters is disabled for the user. This special view contains advanced parameters accessible only by the manufacturer.

III. Protections

In order to ensure a safe and faultless operation, the regulator has been provided with numerous protections. In the case of an alarm, an acoustic warning is sounded and the display shows a corresponding message.

Press *MENU* button to restore the controller to operation. In the case of the **C.H. Temperature Too High** alarm, wait until the temperature drops below the alarm value.

III.a) Thermal protection

The boiler is protected with an additional bimetal sensor (located at the boiler temperature sensor) that disables the fan when the temperature

exceeds the critical value: 85°C. This is to prevent water from boiling in the system when the boiler has been overheated or the controller is damaged. When the protective function is enabled and the temperature drops to a safe value, the sensor will automatically restart the device and the alarm will be deactivated. If the sensor is damaged or overheated, the burner, fan and feeder are disabled.

III.b) Automatic Sensor Check

When the temperature sensor of the central heating or hot consumption water is damaged, an alarm is sounded with an additional indication shown in the display, e.g.: „***C.H. Sensor Damaged***".

<p>ALARM C.H. SENSOR DAMAGED</p>
--

Blow is disabled and both pumps are activated simultaneously, regardless of the temperature.

If the central heating sensor is damaged, the alarm will remain active until the sensor is replaced. If the hot consumption water sensor is damaged, press **MENU** **to** deactivate the alarm and restore the single (house heating) pump mode. To be able to operate the boiler in all modes, it is necessary to replace the sensor.

III.c) Temperature Protection

The regulator features an additional protection in case the bimetal sensor is damaged. After the temperature exceeds 85°C, the alarm is sounded with the display showing the following message:

<p>ALARM TEMPERATURE TOO</p>
--

The current temperature is read from an electronic sensor and processed

by the thermoregulator. When the alarm temperature is exceeded, the fan is shut off and both pumps begin to run in order to distribute hot consumption water throughout the system.

III.d) Anti-Boil Protection

This protective function is used only with the **water heater priority** mode. For example, when the water heater setpoint temperature is 55°C and the boiler temperature rises to 67°C (5°C over the so-called *priority temperature*), the controller shuts off the fan. If the boiler temperature reaches 80°C, the C.H. pump will be activated. If the temperature continues to rise, the alarm will be activated at 85°C. Such condition may appear when the water heater or the pump is damaged or when the sensor has been improperly installed. However, if the temperature drops, the controller will activate the fan at 66°C and it will remain in the duty mode maintaining the priority temperature of 62°C.

III.e) Monitoring the flue gas outlet temperature

23 °C	98 °C	50% 
C.H.	FLUE	FAN

This sensor constantly monitors the flue gas outlet temperature. If the sensor is damaged, disconnected from the controller or removed from the flue conduit, **Flue Gas Sensor Damaged** message will appear on the display. This will cause the controller to switch to the emergency mode. In such case, only boiler temperature is used. The controller is operated using only the boiler sensor and the zPID function remains active without the flue gas outlet sensor.

III.f) Fuse

The regulator has a network protection WT 3.15 A tube fuse. Higher current ratings may cause damage to the controller.

IV. Maintenance

Before and during the heating season, the **ST-81** controller should be checked for condition of its cables. You should also check if the controller is properly mounted and clean it if dusty or dirty. It is advisable to measure grounding parameters for the motors (central heating pump, hot consumption water pump and fan)

ST-81 Technical Specifications

No.	Specification	Unit	
1	Supply Voltage	V	230V/50Hz +/-10%
2	Power consumption	W	5
3	Ambient temperature	°C	5÷50
4	Circulation pump outlet load	A	0,5
5	Fan outlet load	A	0,6
6	Temperature measurement range	°C	0÷90
7	Measurement accuracy	°C	1
8	Sensor thermal resistance	°C	-25÷90
9	Fuse insert	A	3,15

V. Assembly

ATTENTION: all assembly works must only be carried out by qualified persons. During assembly, the device **must be** disconnected (make sure the power cord is unplugged)!

ATTENTION: improper cable connections may damage the regulator!

The regulator may not be operated in a closed-circuit central heating system. It is necessary to provide for safety valves, pressure valves and a surge tank in order to prevent water from boiling in the central heating system.

V.a) Cable Connection Diagram for Controller

Pay special attention to cable connections during assembly. Especially, the ground wire should be connected properly.

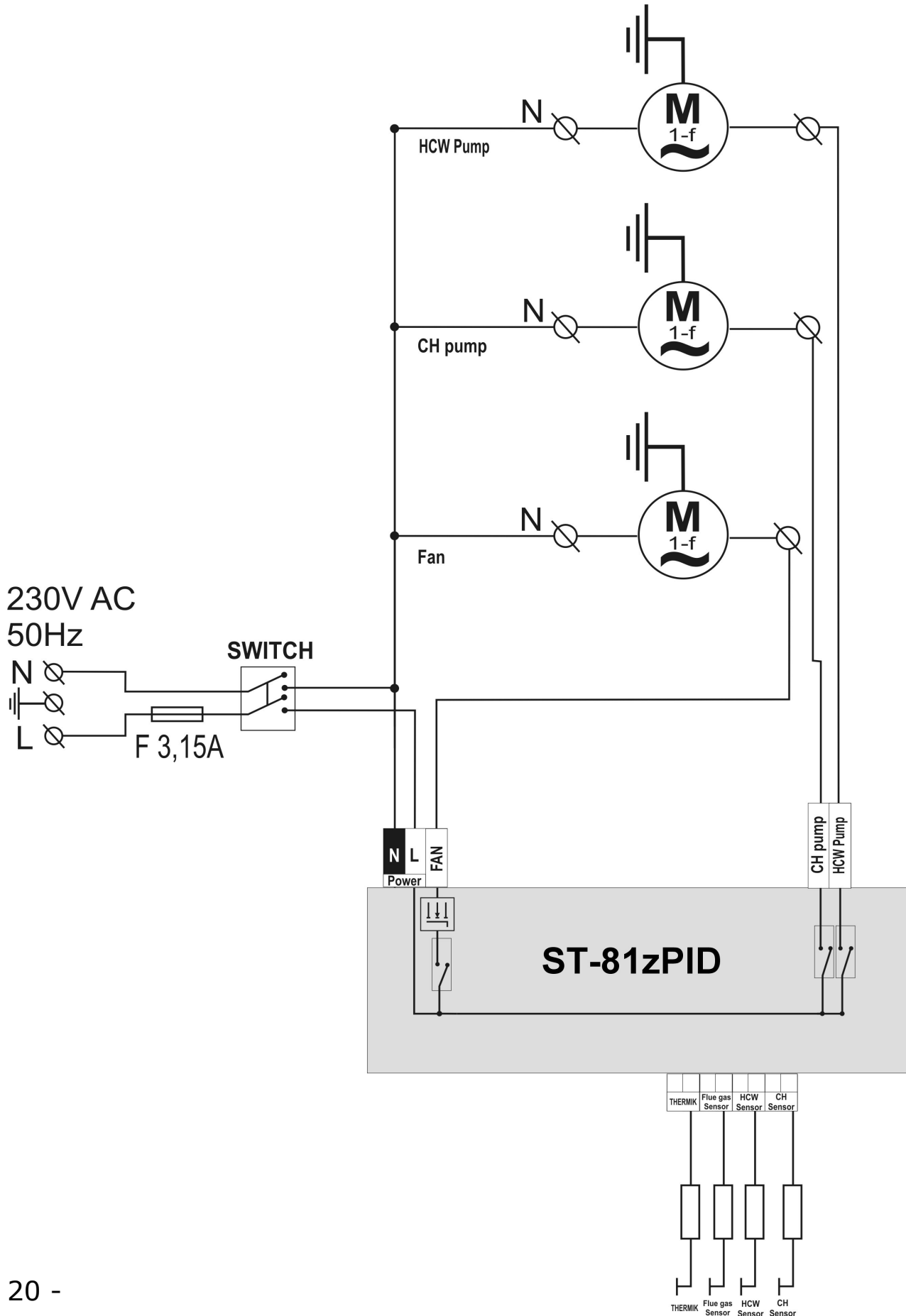



We are committed to protecting the environment. Manufacturing electronic devices imposes an obligation of providing for environmentally safe disposal of used electronic components and devices. Hence, we have been entered into a register kept by the Inspection For Environmental Protection. The crossed-out bin symbol on a product means that the product may not be disposed of to household waste containers. Recycling of wastes helps to protect the environment. The user is obliged to transfer their used equipment to a collection point where all electric and electronic components will be recycled.

Table of Contents

I. Description.....	5
II. Regulator Functionality.....	8
II.a) Main Page.....	8
II.b) Changing the central heating and hot consumption water setpoint temperature.....	9
II.c) Firing up/Fan.....	10
II.d) Manual Mode.....	10
II.e) Fuel Type.....	11
II.f) Central Heating Pump Activation.....	11
II.g) H.C.W. Pump Activation.....	12
II.h) Operation Mode.....	12
II.h.1) House Heating.....	12
II.h.2) H.C.W. Priority.....	13
II.h.3) Parallel Pumps.....	13
II.h.4) Summer Mode.....	14
II.i) Main Screen.....	15
II.j) Language.....	16
II.k) Factory Settings.....	16
II.l) Fitting parameters.....	16
III. Protections.....	16
III.a) Thermal protection.....	16
III.b) Automatic Sensor Check.....	17
III.c) Temperature Protection.....	17
III.d) Anti-Boil Protection.....	18
III.e) Monitoring the flue gas outlet temperature.....	18
III.f) Fuse.....	19
IV. Maintenance.....	19
V. Assembly.....	19
V.a) Cable Connection Diagram for Controller.....	20

INSTRUKCJA OBSŁUGI

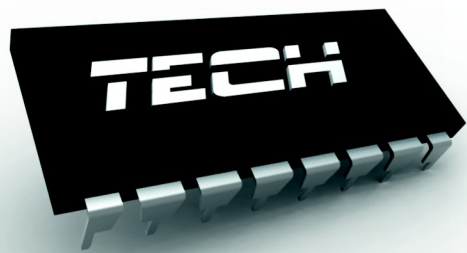

WWW.TECHSTEROWNIKI.PL

TECH Sp.j.
Wieprz 1047A
34-122 Wieprz k.Andrychowa
Tel. +48 33 8759380, +48 33 8705105
+48 33 8751920, +48 33 8704700
Fax. +48 33 8454547
serwis@techsterowniki.pl

Zgłoszenia serwisowe przyjmowane są:

Pn. - Pt.

7:00 - 16:00

Sobota

9:00 - 12:00

TECH